Section 12: Pallet Changer

Installation of Pallet Changer

- 1) The left, front, lower edge of the base must be a minimum of 2" from the floor. Level the machine on the 1.5" leveling pads that were shipped with the machine (see the Fadal Maintenance Manual Pre-Installation/ Installation Section for documentation on leveling the VMC).
- 2) Verify that the X and Y axis cold start positions are correct. The X axis must travel to X-20" and the Y axis must travel to Y-10" and Y+10". Cold start the machine.
- 3) Enter the Parameters page and select the Pallet Changer.
 - a. At the ENTER NEXT COMMAND screen, type SETP and press the ENTER button.
 - b. Press the SPACE BAR to select the second page.
 - c. Press the D button, to page down to the PALLET category. Select the number 2, which answers yes to the question "Do you have a Pallet Changer". Press the ENTER button and then press the MANUAL button to exit the Parameters page.
- 4) Verify that the rail support bolts on the Pallet Receiver are installed and are all the way up.

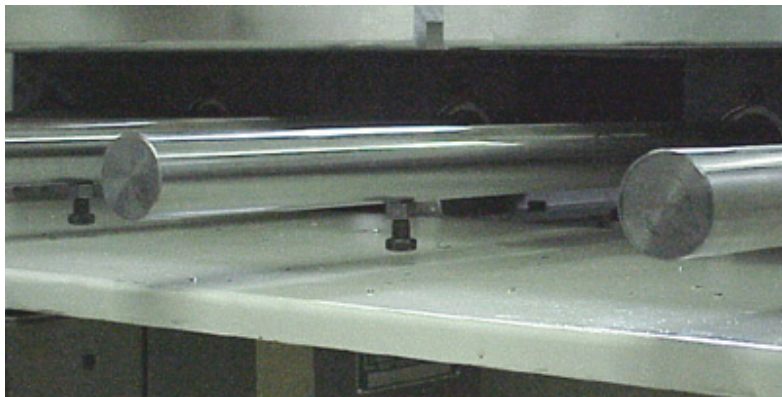

Figure 12-1 Verify Rail Support Bolts are Installed and All the Way Up

- 5) Verify that the rails and the bolts are high enough to clear the VMC sheetmetal. If not, adjust the Pallet Receiver legs clockwise to raise the level of the support rails.

- 6) Move the VMC table to X=-20" and Y=10".
- 7) Open the Pallet Changer door using the UTILITIES command.
 - a. In the ENTER NEXT COMMAND mode, type UT and press the ENTER button.
 - b. Select option #5 PALLET CHANGER.
 - c. Select option #4 SERVICE UTILITY.
 - d. Select option #2 OPEN/CLOSE DOOR.
- 8) Slide the Pallet Changer receiver base into position. Line up the floor plate rails with the bolt holes on the main casting base.

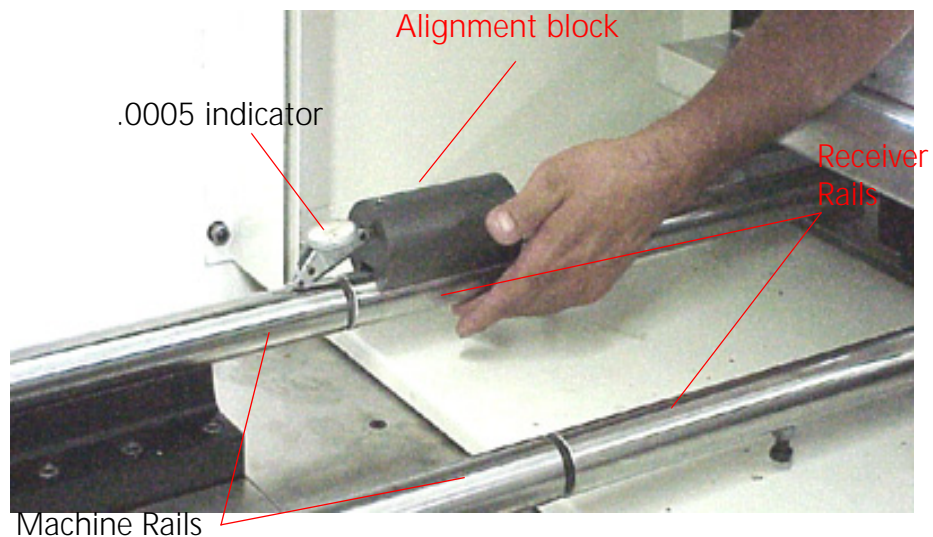

Figure 12-2 Slide Pallet Changer Receiver Base into Position

- 9) Install the bolts for the floor plate rails. Check the alignment visually. Tighten the bolts and then break them loose.
- 10) Level the receiver base. After leveling, verify the gap between the receiver rails and the machine rails is .100" - .200" and the up and down alignment is also .100" - .200".
- 11) To align the rails side to side, move the receiver base left or right until the receiver and machine rails are aligned within .100" - .200".
- 12) Place the Alignment block on the receiver rail and the .0005" indicator on the machine rail and slide the adjustment block toward the machine. The indicator will move, indicating the up and down alignment of the rails. Adjust the receiver base legs to bring the up and down alignment of the receiver and machine rails to within .003".

- 13) Place the Alignment block on the receiver rail and the indicator on the machine rail and rotate the adjustment block to the side. The indicator will move, indicating the side to side alignment of the rails. Move the receiver base to bring the side to side alignment within .002". Check all four rails. If one rail is out of tolerance and cannot be adjusted to within tolerance, the machine or receiver rail may need to be replaced.
- 14) Tighten the bolts on the receiver base legs. After tightening the bolts, perform a check on the alignment by using steps 12 and 13. Re-adjust if necessary.
- 15) Remove the pallet shipping brackets.
- 16) Move pallet A onto the machine by hand. Check for a smooth transition. If binding occurs, return the pallet to the receiver and check the alignment (Steps 12 and 13).
- 17) Once the A pallet travels across the rails smoothly, return it to the receiver and perform the same check on the B pallet.
- 18) Remove the pallet arm safety cover.

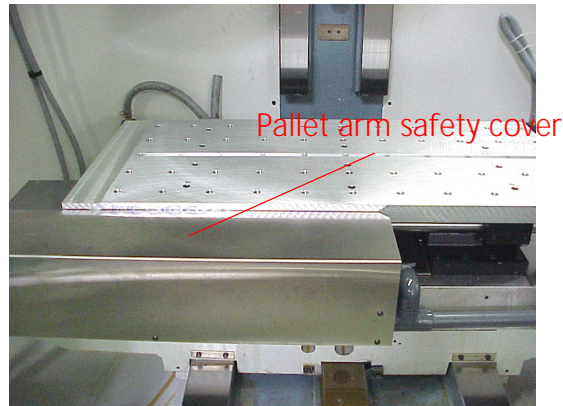

Figure 12-3 Remove Pallet Arm Safety Cover

- 19) Loosen the 5/16" socket head pallet arm bolt. The pallet changer arm will drop down. Swing the arm out of the path of the pallet.
- 20) Release the clamp.
 - a. In the ENTER NEXT COMMAND mode, type UT and press the ENTER button.
 - b. Select option #5 PALLET CHANGER.
 - c. Select option #4 SERVICE UTILITY.

- d. Select option #1 Clamp/Unclamp.

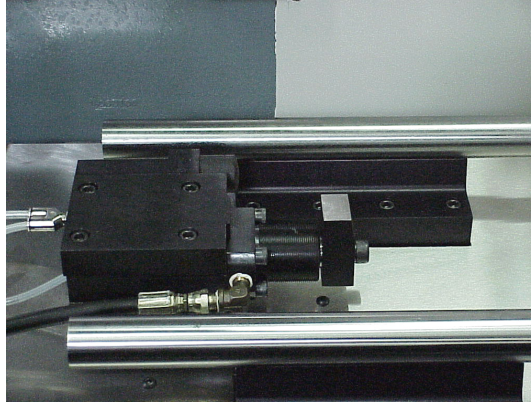

Figure 12-4 Release the Clamp

- 21) Pull pallet A all the way on to the machine table and use the instructions in step #20 to clamp the table in place.
- 22) Position the Pallet Changer Arm roller into the slot of the pallet. Place the roller half way into the slot. The arm should be flush with the top of the pivot pin.
- 23) Tighten the 5/16" socket head pallet arm bolt to 35-40 foot pounds.
- 24) Store pallet A.
 - a. In the ENTER NEXT COMMAND mode, type UT and press the ENTER button.
 - b. Select option #5 PALLET CHANGER
 - c. Select option #4 SERVICE UTILITY
 - d. Select option #3 Store Pallet
- 25) If the pallet moves smoothly, tighten the rail slide bolts that are connected to the base.
- 26) Check pallet A and verify that the pallet is resting properly on the receiver roller. If the pallet is not resting properly on the roller, then adjust the pallet stop block position on the pallet.
 - a. Remove the cover over the roller.
 - Remove the two 5/16" hex head bolts that are holding the cover in place.
 - Remove the cover.
 - b. Loosen the two 9/16" hex head bolts that are located underneath the pallet stop block.

- c. Slide the stop block until it rests properly over the roller.

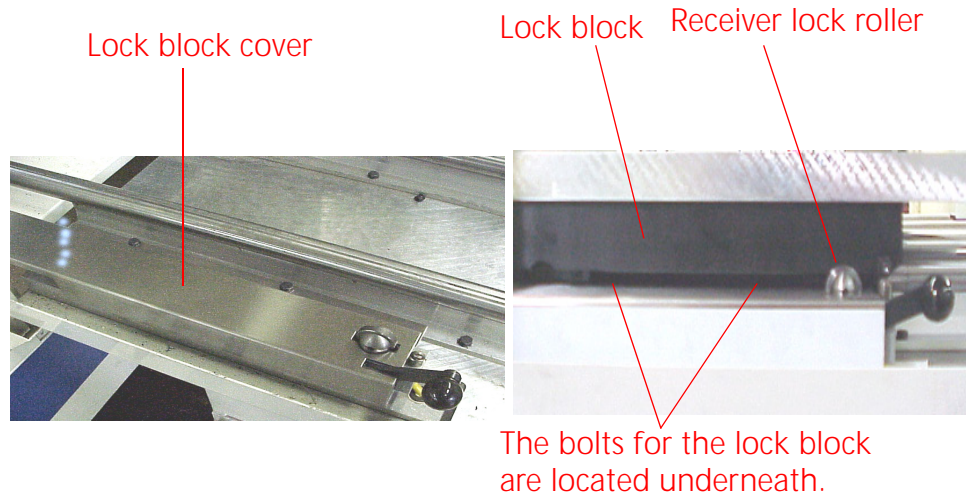

Figure 12-5 Remove Cover; Loosen Bolts; Slide Stop Block Over Roller

- 27) Jog the table back to pallet B and load pallet B.

- a. In the ENTER NEXT COMMAND mode, type UT and press the ENTER button.
- b. Select option #5 PALLET CHANGER; press the ENTER button.
- c. Select option #4 SERVICE UTILITY; press the ENTER button.
- d. Select option #8 JOG.
- e. Press the JOG key on the keypad and jog the Y-axis to Y= -10.
- f. Verify that the arm is lined up with the groove in pallet B. If the arm is not lined up with the groove, move the pallet forward or backward to allow the arm to enter the groove.
- g. Press the manual button to return to the utility menu. Press Option #4 LOAD PALLET.

- 28) If pallet B loaded smoothly, store pallet B and verify that the pallet stop block is resting properly on the roller. If the pallet is not resting properly on the receiver roller, adjust the positioning (refer to step #26).

- 29) Drill holes in the concrete through the holes in the receiver base legs. Install the mounting bolts and tighten.

- 30) Verify the alignment, by performing several pallet changes using the utilities menu.

- 31) Adjust the pallet rail support bolts down until they touch the sheetmetal. Tighten the lock nut.

Installation of Light Curtain

- 1) Attach the front and rear base plates to the pallet receiver (A).
- 2) Fasten the front and back light curtain mirror assemblies to the front and rear base plates. Verify that both mirrors are level (B).
- 3) Attach the receiver and transmitter. Align the receiver and transmitter to the mirror heights (C).
- 4) Attach the controller junction box onto the pallet changer base. Plug the transmitter and receiver cables into the junction box (D).
- 5) Connect the controller junction box to the 1100-3 board for 120v power.

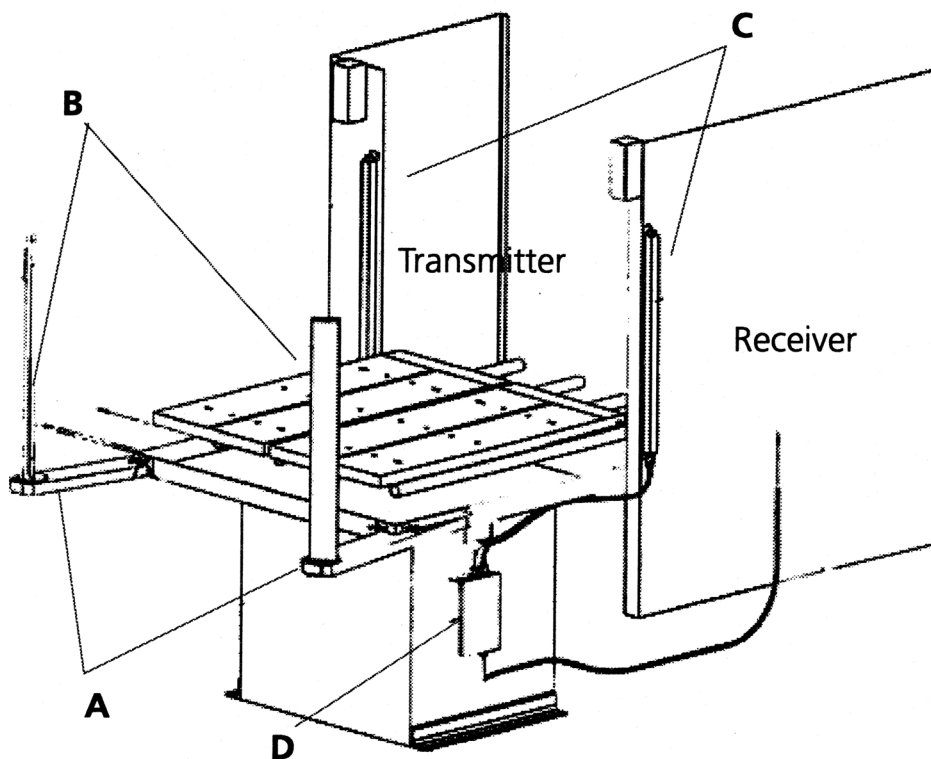

Figure 12-6

A= Front and rear base plates
B= Front and rear mirror assemblies

C= Transmitter and Receiver
D= Junction box

Mirror Alignment **Note:** The transmitter has two lights (one red and one green) located at the top end of the unit. They represent a good alignment (green light) or a bad alignment (red light). There must not be any obstructions within the light curtain while the alignment is being set. Obstructions may keep the transmitter from aligning properly with the receiver.

- 1) Stand next to the transmitter of the light curtain and look into mirror #1.
- 2) Adjust mirror #1 until the mirror #2 can be seen.
- 3) Adjust mirror #2 until the receiver can be seen when looking in mirror #1.
- 4) Repeat the above steps while standing on the receiver side. If the mirrors are aligned properly, the transmitter will be viewed while looking in mirror #2 from the receiver side.
- 5) After the alignment has been set, look at the lights on the transmitter. The green light will be illuminated if the alignment is correct. If the alignment is incorrect, the red light will be illuminated.
- 6) If the red light is illuminated, repeat steps 1-5. Also, try adjusting the receiver or transmitter.

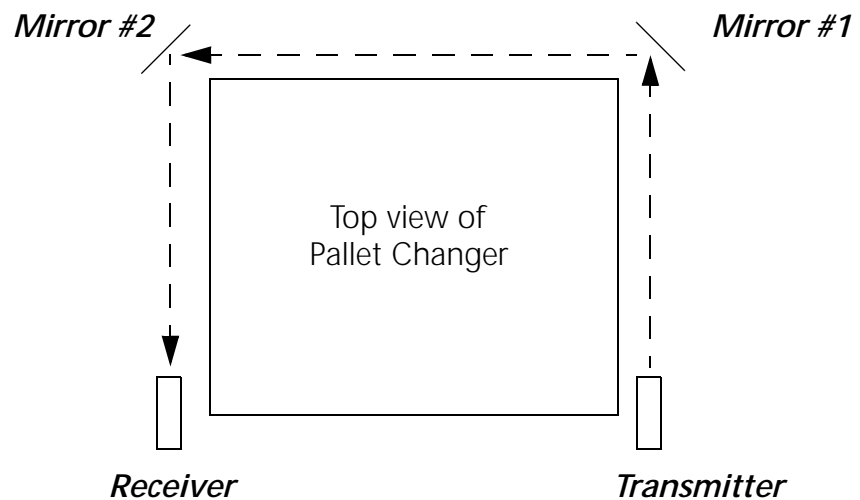

Figure 12-7 Mirror Alignment

Setting the Sensor on the 1840 Board

Purpose During a pallet change, the table will move to the table limits. If there is anything blocking the progress of the Y-axis, the current of the motor will be too high. The 1840 board senses when the Y-axis motor is receiving too much current and will inhibit the pallet operation.



IMPORTANT

This procedure is for DC machines only. AC machines monitor motor overload through the axis controller card.

- 1) Install the 1840 board into the VMC.
- 2) Power on the VMC.
- 3) Enter the ENTER NEXT COMMAND mode and enter a program for testing the sensor.
 - a. Type PR and press the ENTER button.
 - b. Select option #3 START A NEW PROGRAM.
 - c. Type a program number that is not currently in the system and press the ENTER button.
 - d. Select option #6 EXIT.
 - e. Type IN and press the ENTER button.
 - f. Enter the following program:

```
N1 M49 F150. G1 G91  
N2 Y5.  
N3 Y-5.  
N4 M99P1
```

- 4) Start the program. Press the AUTO button to start the program running.
- 5) On the 1840 board, turn the pot clockwise until the red LED is on continuously.
- 6) Turn the pot counterclockwise until the LED gives one solid blink once at the end of each move.
- 7) Stop the program.
 - a. Press the SLIDE HOLD button.
 - b. Press the MANUAL button.

- 8) Make a pallet change In the MANUAL DATA INPUT mode (do not make a pallet change from the UTILITIES menu; a pallet change from the UTILITIES menu does not utilize all of the functions of a complete pallet change).

In the MANUAL DATA INPUT mode:

- a. Turn the Rapid travel 3-position switch to 100%.
 - b. Type M31.
 - c. Press the ENTER BUTTON.
- 9) If the INHIBIT message is displayed on the monitor, repeat steps #3-#8.

Operation

The pallet changer may be operated within the program or by use of the UT (Utilities) command.

Pallets

There are 2 pallets on the pallet changer. They are identified as Pallet A and Pallet B. Pallet A is the closest pallet to the operator.

There are 3 positions for the pallets: loaded, stored, and working.

- The **loaded** position is when the pallet is locked onto the table with the hydraulic clamp.
 - The **stored** position is when the pallet is ready to be loaded onto the table.
 - The **working** position is when the pallet is released from the stored position. The pallet must be moved to this position manually. Push the release lever down, to pull the table to the working position.
- 1) The pallets move on rails with circular bearings.
 - 2) The pallet is locked in place on the table with a hydraulic clamp.
 - 3) The clamp is released with program coding of a pallet change or through the utility menu.

M-Functions

There are 3 M-Functions that may be used to operate the pallet changer:

- **M31 Exchange Pallets** - This function performs a pallet exchange. The pallet changer will store the current pallet and load the other pallet.
- **M32 Store and Load Pallet A** - This function is used when only pallet A is to be utilized. This exchange is performed the same as the M31 function. When pallet A is on the table, it is placed in the stored position. The machine will enter the waiting state, while the operator changes parts. When the START button is pressed, pallet A is loaded.

- **M33 Store and Load Pallet B** - This function is used when only pallet B is to be utilized. This exchange is performed the same as the M31 function. When pallet B is on the table, it is placed in the stored position. The machine will enter the waiting state, while the operator changes parts. When the START button is pressed, pallet A is loaded.

Manual Operation

The pallet changer is operated manually by using the UTILITIES (UT) menu. The UT menu gives the operator options to manipulate the pallets, Jog the machine, and check the sensors. To enter the UT menu:

- 1) Press the MANUAL button until ENTER NEXT COMMAND is displayed.
- 2) Type UT and press the ENTER button. When the UTILITIES menu is entered, the following options appear:

UTILITY OPTIONS:

- 1 TOOL SETTING CYCLE
 - 2 FIXTURE OFFSET SETTING
 - 3 TEST TS-20 PROBE
 - 4 TEST MP PROBE
 - 5 PALLET CHANGER
 - 6 CLOCKS
 - 7 EXIT
- ENTER OPTION NUMBER

Once the UTILITIES menu has been entered, the operator will be able to select the pallet changer option.

- 1) Select option #5 PALLET CHANGER and press the ENTER button.
- 2) The following menu will appear:

PALLET CONTROLS:

- 1 EXCHANGE PALLETS (A-B)
 - 2 LOAD-STORE PALLET A
 - 3 LOAD-STORE PALLET B
 - 4 SERVICE UTILITY
 - 5 EXIT
- ENTER OPTION NUMBER

Choosing options 1-4 will allow the operator to manipulate the pallet changer without programming the CNC. To enter an option, type the number of the option and press the ENTER button.

Option 1: When option 1 is selected, the following will occur:

- 1) The pallet changer door opens.
- 2) The machine enters the waiting state, and the message PRESS START TO MOVE PALLET appears at the bottom of the screen. If a table move is necessary, the X, Y, M48, F150, and G1 line of code will also appear. When the START button is pressed, the machine will move into position for the pallet change.
- 3) When the START button is pressed the hydraulic clamp is released and the pallet will move to the stored position. The table then moves into position to receive the other pallet. The pallet is moved into the load position on the table. The hydraulic clamp is engaged and the door is closed.
- 4) The PALLET CONTROLS menu is displayed.

Option 2: If pallet B is on the table, this option works just like option 1. If pallet A is on the table, the machine stores pallet A.

- 1) The pallet door will open.
- 2) The table moves to the position for storing pallet A.
- 3) The machine stores pallet A.

Option 3: If pallet A is on the table, this option works just like option 1. If pallet B is on the table, the machine stores pallet B.

- 1) The pallet door will open.
- 2) The table moves to the position for storing pallet B.
- 3) The machine stores pallet B.

Option 4: When this option is selected, the following menu appears:

PALLET SERVICE UTILITY

- 1 CLAMP/UNCLAMP
 - 2 OPEN/CLOSE DOOR
 - 3 STORE PALLET
 - 4 LOAD PALLET
 - 5 MOVE TO TABLE A
 - 6 MOVE TO TABLE B
 - 7 DISPLAY SWITCHES
 - 8 JOG
 - 9 EXIT
- ENTER OPTION NUMBER

Option 1: This option toggles the hydraulic clamp on and off.

Option 2: This option opens and closes the pallet door.

Option 3: The table must be in position to store the pallet (X=-20., Y=-10. or X=-20., Y=10.). When the table is in position, the following will occur:

- a. The door will open.
- b. The machine will enter the waiting state and display the message PRESS START TO MOVE PALLET.
- c. When the START button is pressed, the pallet moves to the stored position on the receiver. While moving to the stored position, the message STORING PALLET... is displayed. If the pallet is already stored, the message STORING PALLET... PALLET IN STORAGE will appear and the control returns to the command mode.

Option 4: This option is only used when the table is empty. The table must be in position to load the pallet (X=-20., Y=-10. or X=-20., Y=10.). When the table is in position, the following will occur:

- a. The door will open.
- b. The machine will enter the waiting state and display the message PRESS START TO MOVE PALLET.
- c. When the START button is pressed, the pallet moves to the loaded position on the receiver. While moving to the loaded position, the message LOADING PALLET... is displayed. If the table is not aligned, the message LOADING PALLET... RAILS NOT ALIGNED will appear and the control returns to the command mode.

Option 5 & 6: These options will move the table to the position of either pallet A or pallet B. If there is a pallet on the table, the machine will only move the table to the position of the pallet that is on the table. After storing a pallet with option 3, these options can be used to move the table back and forth between pallet A and B.

Option 7: This option will display the status of all the switches applicable to the pallet changer. The following will be displayed:

PALLET SWITCHES:

LEFT
RIGHT
ALIGNED
A
B
OPEN
CLOSED
INHIBITED
PUMP ON
MOVING LEFT
MOVING RIGHT
OPENING
UNCLAMPED
PRESS A KEY TO EXIT

Option 8: This option allows the operator to jog the machine in any axis. After selecting this option, the control will display the message PRESS JOG TO CONTINUE OR MANUAL TO EXIT. Press the JOG button and the JOG function will be enabled.

Option 9: This option will exit the current menu.

**Maintenance
Schedule****Each Part Cycle**

- 1) Use an M20 in the program to make it automatic. Frequent washing out of chips prevents them from building up into difficult-to-remove piles.
- 2) Blow away any chips that may lodge underneath Pallet in Hydraulic Arm groove.

Daily Maintenance

- 1) Put both Pallets away onto stand. Put tool in spindle. Wash down interior with coolant hose nozzle, using care to keep splash away from Automatic Tool Changer, Head assembly, or any wiring connections.
- 2) Clean chips from trough behind Table and Saddle, and on Sliding.
- 3) Guard, and inspect between front Y-axis way cover and front of machine for chip buildup.
- 4) Remove screen/tank cover over fluid tank, and clean screen protecting pumps.
- 5) Using tool, check for any chip buildup in tank ahead of screen.
- 6) Check tank reservoir fluid level, and refill as necessary.
- 7) Check Waylube level, refill with Castrol Magna BD68, Shell Tonna V68, or Mobil Vactra #2.
- 8) Check for air pressure. Single regulators should be set for 80PSI. Dual regulators should be set at 80PSI on the left gauge, and 90-100PSI maximum on the right gauge.
- 9) Move X-axis to either side, and flip over outer X-axis way cover. Inspect for chip buildup, and clean. Check for waylube presence on both X-axis ways. Inspect Z-axis and Y-axis as well.
- 10) Check pressures/vacuum on Coolant-Thru pump filter and replace filter, if necessary.

Weekly Maintenance

- 1) Check Hydraulic Fluid level for Pallet Clamp on top of machine. Use Mobil DTE Heavy Medium.
- 2) Remove Hydraulic Arm pump cover, and inspect Hydraulic Arm system, refilling fluid if necessary.
- 3) Check Hydraulic Arm chain tension by push/pull on arm.

- 4) Remove Head Cover, and inspect fluid lines for Hi/Lo Idler assembly, refilling, if necessary.
- 5) Remove all tools from tool changer, and clean out any chip buildup found. When returning tools to ATC, inspect retention ring tension on tool holders for excessive looseness, replacing rings, if necessary.
- 6) Disconnect front Y-axis way cover from saddle, and check for chip buildup.
- 7) Inspect under Y-axis motor for chips, and clear out drain ports under Y-axis ways nearest the column.

Monthly Maintenance

- 1) Carefully remove pallets, and grease rail bearings, using care not to damage lip seals.
- 2) Remove spindle motor top filter cover, and inspect filter. Replace, if necessary.
- 3) Inspect Pallet Roller latch system for both Pallets on stand.
- 4) Check Pallet Lift Door for smooth operation.
- 5) Inspect Chiller cabinet for low fluid in container, should be 1/2 to 3/4 full.
- 6) Inspect Chiller recirculation pump filter, and clean as needed.
- 7) Blow air into top of Chiller louvers to clear out dirt collecting on condenser.
- 8) At bottom of rear cabinet, remove fan filter screen and clean.
- 9) Inspect front door rollers, tightening as necessary.
- 10) Check door interlock system for proper operation.
- 11) Remove head cover and inspect belts, and check for any Coolant-thru system leaks.
- 12) Inspect all cables, hoses, and tubing for looseness, or damage.

This page intentionally left blank.