

SAFETY SECTION

FADAL MACHINING CENTERS, LLC

Corporate Office.....phone (818) 407-1400fax (818) 407-0020
Service / Partsphone (818) 727-2100fax (818) 407-1004
Programming Support.....phone (818) 727-2100fax (818) 407-0061

support@fadal.com
20701 Plummer Street, Chatsworth, California 91311 USA

Drawings in this manual are for reference only and do not necessarily depict the latest revision.

TABLE OF CONTENTS

1.0 SAFETY WARNINGS	1
2.0 GENERAL	2
2.1 WARNINGS AND CAUTIONS	4
2.2 PICTORIALS	4
2.3 POTENTIAL HAZARDS TO PERSONNEL	4
2.3.1 ROTATING CUTTING TOOLS	4
2.3.2 ELECTRIC SHOCK	5
2.3.3 SHARP EDGES ON CUTTING TOOLS	5
2.3.4 NOISE (CE COMPLIANCE)	5
2.3.5 COMPRESSED AIR (CE COMPLIANCE)	6
2.4 PHYSICAL ENVIROMENTAL AND OPERATING CONDITIONS	6
3.0 US SAFETY LABELS	8
3.1 DANGER	8
3.1.1 SAFETY INSTRUCTIONS	8
3.1.2 ROTATING CUTTING TOOLS	10
3.1.3 MOVING PARTS	11
3.1.4 HAZARDOUS VOLTAGES	11
3.1.5 ROTATING CUTTING TOOLS	12
3.1.6 SPINDLE HEAD IS NOT COUNTERBALANCED	12
3.1.7 VERTICAL AXIS	13
3.1.8 AUGER AND CONVEYOUR	14
3.1.9 PALLET DOOR	14
3.2 WARNING	15
3.2.1 SHARP EDGES ON CUTTING TOOLS	15
3.2.2 HAZARDOUS VOLTAGES	15
3.2.3 READ OPERATOR'S MANUAL	16
3.2.4 EYE AND EAR PROTECTION	16
3.2.5 VERTICAL AXIS	17
3.2.6 COMPRESSED AIR	18
3.3 CAUTION	19
3.3.1 WEIGHT	19
3.4 OTHER WARNINGS	20
3.4.1 HAZARDOUS VOLTAGES	20
3.4.2 SERVICE BY AUTHORIZED PERSONNEL ONLY	20
3.4.3 MAINTENANCE LABELS	21
3.4.4 GROUNDING REQUIREMENTS	22

4.0 CE SAFETY LABELS	23
4.1 TRIANGLES	23
4.1.1 ROTATING CUTTING TOOLS	23
4.1.2 BELT OR CHAIN DRIVE	23
4.1.3 HAZARDOUS VOLTAGES	24
4.1.4 EYE AND EAR PROTECTION	24
4.1.5 EYE PROTECTION	25
4.1.6 COMPRESSED AIR	25
4.1.7 AUGER AND CONVEYOUR	26
4.1.8 MOVING PARTS	26
4.1.9 FORCE FROM SIDE	27
4.1.10 DRAWING IN	27
4.1.11 IMPACT FROM ABOVE	28
4.1.12 CRUSH FROM ABOVE	28
4.2 CIRCLES	29
4.2.1 NO OPEN OR REMOVED GUARDS	29
4.2.2 WEAR EYE PROTECTION	29
4.2.3 WEAR EAR PROTECTION	30
4.2.4 READ OPERATOR'S MANUAL	30
4.2.5 LOCKOUT ELECTRICAL POWER	31
4.3 INFORMATION	31
4.3.1 MAXIMUM TOOL DIAMETER	31
4.3.2 MAXIMUM RPM	32
4.4 COMBINED SHAPES	33
5.0 INDEX	34
5.1 ALPHABETICAL ORDER OF LABELS	34
5.2 NUMERICAL ORDER OF PART NO	36

1.0 SAFETY WARNINGS

1. KEEP DOORS CLOSED WHILE MACHINING.
2. DO NOT DISCONNECT THE FRONT DOOR SAFETY SWITCHES.
3. The front door is equipped with an interlock to prevent automatic of the VMC from when the door is open. Under no circumstances should the operator disable or remove the interlocks. If power is lost to the VMC, the spindle may coast for 30 seconds or more. Under no circumstances should the operator open the door before the spindle stops rotating completely.
4. READ AND UNDERSTAND THE OPERATOR'S MANUAL before using the VMC.
5. WARNING! WEAR ANSI or CE APPROVED SAFETY GLASSES AT ALL TIMES when operating machine. Everyday glasses are not designed for protection. Only ANSI or CE approved safety glasses have impact resistant lenses.
6. WEAR PROPER APPAREL. Do not wear loose clothing, gloves, neckties, rings, bracelets, or other jewelry that might get caught in moving parts or areas of potential electric shock. Non-slip footwear is recommended.
7. CONTAIN LONG HAIR. Tie long hair back and wear protective hair covering to contain long hair.
8. DO NOT EXCEED THE MANUFACTURER'S RECOMMENDED MAXIMUM RPM FOR THE TOOL. When tools are placed in the spindle, verify the current RPM commanded in the control before starting the spindle.
9. HEARING PROTECTION must be worn when operations exceed 90 (85 CE) decibels.
10. USE A NIOSH OR CE APPROVED DUST MASK OR RESPIRATOR. Protection is recommended when cutting operations are dusty or exceed the permissible exposure limit.
11. DO NOT OPERATE THE MACHINE UNDER THE INFLUENCE OF DRUGS OR ALCOHOL, PRESCRIBED OR OTHERWISE.
12. READ THE SAFETY WARNINGS SUPPLIED WITH ALL TOOLING.
13. KEEP WORK AREA CLEAN. Good housekeeping practices encourage safety.
14. Read SPINDLE, MANUALLY LOADING & UNLOADING A HOLDER in the Operator's Manual.

15. REMOVE ADJUSTING KEYS AND WRENCHES. Always check that keys and wrenches are removed from tools and tooling before starting the machine.
16. MAINTAIN TOOLS WITH CARE. Keep tools sharp and clean for best performance and to reduce the risk of injury. Follow instructions for lubrication and for changing accessories.
17. SECURE TOOLS PROPERLY IN THEIR HOLDERS.
18. SECURE WORK. Use standard machining practices for holding (fixturing) material to be machined.
19. MAINTAIN THE TOOLS WITH CARE. Keep tools sharp and clean for best performance and reduction of the risk of injury. Follow instructions for lubrication and for changing accessories.
20. DO NOT FORCE TOOL. Tools are designed to perform properly and safely at proper rates. Keep tools sharp.
21. USE THE CORRECT TOOL. Do not attempt to use tools or attachments to perform a job for which they were not designed.
22. DO NOT OVERREACH. Keep proper footing and balance at all times. Use a steady object for support when reaching over the machine.
23. ALWAYS DEBUG A NEW PROGRAM before running it in the AUTO mode. (See DEBUG PROGRAM in the User's Manual.)
24. DO NOT OPERATE THE MACHINE IN AN UNSAFE ENVIRONMENT. Do not use the machine in damp or wet locations, or expose to rain. Keep the work area well lighted. Do not turn the VMC on or try to operate it if there are explosive or flammable gases present.
25. The machine is not intended for use with flammable or harmful substances.
26. Take appropriate additional safety precautions and measures when working with magnesium, wood, or other combustible materials.
27. Dust removal equipment is needed when working with dust-producing materials or procedures.
28. REDUCE THE RISK OF UNINTENTIONAL STARTING. Power off the machine at the main disconnect switch and use the proper lockout/tagout procedures while working within the chip enclosure.
29. NEVER WORK ON LIVE ELECTRICAL CIRCUITS. Power off the machine at the main disconnect switch and lock out when working inside any of the electronic cabinets.
30. USE RECOMMENDED ACCESSORIES. Refer to the User's Manual for FADAL recommended accessories. Unapproved accessories increase the risk of injury.

31. NEVER STAND ON OR IN THE MACHINE. Besides the risk of slipping or falling, serious injury can occur if a tool is unintentionally contacted.
32. CHECK FOR DAMAGED PARTS. Always check all parts for binding, breakage, and any other condition that will affect the proper operation of the machine and/or increase the risk of injury. Damaged or missing parts must be repaired or replaced BEFORE operating the machine.
33. NEVER LEAVE THE MACHINE UNATTENDED. Turn off the power to the machine when leaving the machine unattended. Never leave the machine until it comes to a complete stop.
34. WIPE UP SPILLS. Immediately cover with absorbent material and wipe up coolant and oil spills around the machine. Correct the cause of the leakage to prevent any hazards.
35. ELECTRICAL INSTALLATION OF THE MACHINE MUST BE DONE BY A QUALIFIED ELECTRICIAN.
36. The machine tool MUST BE connected to a grounded, metal, permanent wiring system, or to a system having an equipment-grounding conductor.
37. ONLY FADAL OR FADAL DISTRIBUTOR FACTORY AUTHORIZED INDIVIDUALS MAY INSTALL THE MACHINE.
38. Do not enter enclosure area for service or maintenance unless machine is off and power is locked out. Due to danger of slips or falls on a wet or oily surface, table and enclosure floor should be clean and dry before using them for maintenance access.
39. Contact FADAL or your local distributor for all repair parts and service.
40. USE PROPER SAFETY GLOVES WHEN HANDLING SHARP OR JAGGED EDGES. Do not wear gloves around rotating machinery.
41. The Poly-carbonate viewing panels are an integral part of safety enclosure for the VMC. They must be inspected at least monthly for any signs of reduced effectiveness (such as cracking or crazing) and replaced immediately, if such signs or other indications of reduced effectiveness are noticed. Furthermore, tests have indicated that coolants can reduce the effectiveness of the panels over a period of time, therefore the panels should be replaced, regardless of condition, at least every two years.

2.0 GENERAL

A carelessly or improperly operated VMC can cause serious injury or death as well as damage or destruction of equipment. The emergency and safety procedures in this manual are to help users operate the VMC in a safe manner. The warnings in this manual follow accepted industry safety practices. Tasks involving toxic materials must be reviewed and approved by an industrial hygienist or safety engineer.

Fadal has no control over the applications the operator may use the VMC for and is not responsible for injuries or equipment damage. Read and understand the *Operator's Manual*. The safe use and disposal of all hazardous materials processed or used by the VMC is the responsibility of the user. All safety warnings and procedures must be followed.

It is the sole responsibility of the user to comply with all local, state, national (Federal), international and environmental safety laws and regulations applicable to the VMC and its use.

2.1 WARNINGS AND CAUTIONS

This manual contains information that will assist qualified operators and maintenance personnel. Unqualified operators should never attempt to operate or perform maintenance on the VMC.

2.2 PICTORIALS

Pictorials are used within warnings to rapidly communicate a hazard to the reader. The pictorials and their meaning are given in this section.

2.3 POTENTIAL HAZARDS TO PERSONNEL

The most serious potential hazards associated with the VMC are:

- rotating cutting tools
- electric shock
- sharp edges on cutting tools
- noise
- compressed air

2.3.1 ROTATING CUTTING TOOLS

Rotating cutting tools used by the VMC create potential hazards of entanglement. A cutting hazard is also possible if the operator comes into contact with rotating cutting tools. The Poly-carbonate shield is equipped with an interlock to prevent the VMC from operating when the shield is opened.

Under no circumstances should operators disable or remove the interlocks.

If the interlock is not functioning properly, qualified maintenance personnel should be notified and the VMC must not be used until it is functioning properly.

Prior to starting any job, the VMC operator should inspect all of the cutting tools being used to ensure they are in good condition and free from defects such as cracks. The operator should also insure that only the appropriate cutting tools for the material being machined are present.

Using the wrong or a damaged tool can result in the failure of the tool or material being machined. Failure of either can lead to pieces of either the tool or the material being ejected at extremely high speed. Ejection of either can lead to serious injury or death to personnel in the vicinity. Major equipment damage could also be sustained.

2.3.2 ELECTRIC SHOCK

The VMC has numerous subsystems powered by high voltage electricity. This electricity is not a hazard during most operations, however certain maintenance operations conducted by qualified individuals may require the defeat of interlocks so that power may be maintained during diagnostic or adjustment tasks. Under no circumstances should the operator defeat any interlocks.

Read all applicable manuals and follow their warnings to prevent accidental electric shock. Operators must never remove shields or panels, nor should operators bypass or otherwise disable interlocks.

2.3.3 SHARP EDGES ON CUTTING TOOLS

Cutting tools have sharp edges that can lead to a serious cut. The tools used on the VMC are stored in a tool tray when not being used. Under most circumstances they pose no threat to operator or maintenance personnel. It is possible for personnel to come into contact with stationary cutting tools during job setup or when replacing cutting tools for any reason. Extreme care must be taken to avoid coming into contact with the sharp edges on cutting tools.

2.3.4 NOISE

Exposure to occupational hazardous noise or prolonged exposure to noise above 85 decibels may cause permanent hearing damage. The sound of noise the VMC produces varies by the type of material, speed of the cut, and several other factors.

To prevent loss of hearing from the noise of an operating VMC, hearing protection must always be worn by personnel exposed to noise above 85 decibels or above. The level of protection required may vary because of variation in the amount of noise being produced by the VMC. To insure

adequate hearing protection is attained, compliance with CE standards is required. Consult a qualified industrial hygienist or safety engineer to insure adequate protection prior to operating the VMC.

Continuous equivalent A-weighted sound pressure at workstation is 77dB(A) or less when tested according to Annex D of prEN 12417.

The figures quoted are emission levels and are not necessarily safe working levels. While there is a correlation between the emission and exposure levels, this cannot be used reliably to determine whether or not further precautions are required. Factors that influence the actual level of exposure of the workforce include characteristics of the work room, the other sources of noise, etc. i.e., the number of machines and other adjacent processes. Also the permissible exposure level can vary from country to country. This information, however, will enable the user of the machine to make a better evaluation of the hazard and risk.

2.3.5 COMPRESSED AIR

Compressed air poses a potential hazard from flying debris. Under normal conditions the compressed air may not present a hazard to the operator. Failure of any component of a compressed air system may cause parts to be ejected at high speed. Operators and maintenance personnel must always wear eye protection that meets OSHA standards and ANSI standard Z87.1 (or CE standards) when working on systems that use compressed air.

The operator may also use their shop's compressed air to remove debris from material being machined. If shop air is used for this purpose, it must be done in accordance with OSHA or CE standards. Alternative means of debris removal, such as debris rakes, should be considered. **UNDER NO CIRCUMSTANCES SHOULD THE OPERATOR ATTEMPT TO REMOVE DEBRIS WHILE THE VMC IS RUNNING.** Consult a qualified industrial hygienist or safety engineer to insure debris removal is accomplished in a safe manner and in a manner that complies with local, state, national (Federal), and international regulations.

2.4 PHYSICAL ENVIRONMENTAL AND OPERATING CONDITIONS CE SPECIFICATIONS.

FADAL VMCs meet or exceed the environmental requirements stated in EN 60204-1:1992 section 4.4.

Electromagnetic Compatibility meets or exceeds the levels specified by EN 50081-2:1993 and EN 50082-2:1995.

Ambient air temperature conforms as specified in EN60204-1:1992 section 4.4.2 (+5 deg C to +40 deg C).

Humidity conforms as specified in EN60204-1:1992 section 4.4.3 (relative humidity 30% to 95% non-condensing).

Altitude conforms as specified in EN60204-1:1992 section 4.4.4 (maximum altitude without derating exceeds 1000 meters above sea level).

Contaminants conform as specified in EN60204-1:1992 section 4.4.5. Equipment is not intended for use in a corrosive atmosphere. Equipment that will be used in an environment with excessive amounts of fine conductive particulate matter (e.g. graphite) must be ordered with the graphite restraint package.

3.0 US SAFETY LABELS

3.1 DANGER





“DANGER” - indicates an imminently hazardous situation which, if not avoided, will result in death or serious injury.

3.1.1 SAFETY INSTRUCTIONS

SAFETY INSTRUCTIONS

DANGER

Rotating machines create hazards from rotating cutting tools, belts and pulleys, high voltage electricity, noise, and compressed air.





- Rotating cutting tools can severely injure you. NEVER place any part of your body near rotating cutting tools. Injured cutting tools can damage tools being operated. DO NOT operate this machine unless guards are closed. DO NOT operate this machine unless doors, lids, locks and woks are properly.
- Rotating pulleys and belts can severely injure you. NEVER place any part of your body near rotating or moving parts. ALWAYS ensure guards are closed before operating this machine.
- High voltage electricity can severely injure you. NEVER attempt to adjust or repair electrical circuits unless you are familiar with the circuits and are qualified to work safely on the electrical circuits. ALWAYS seek out electrical circuits before attempting to work on this machine.
- Exposure to loud working for noise can lead to permanent hearing loss. DO NOT operate this machine without hearing protection. ALWAYS wear hearing protection that meets Occupational Safety and Health Administration (OSHA) standards to reduce the noise.
- Compressed air can injure you. DO NOT work on compressed air systems without first disconnecting the source of compressed air. ALWAYS wear eye protection when performing maintenance on compressed air systems. ONLY authorized, qualified persons familiar with the compressed air system should perform maintenance on the compressed air system.

Safety Instruction 1.

SAFETY INSTRUCTIONS

⚠ DANGER

All milling machines contain hazards from rotating cutting tools, belts and pulleys, high voltage electricity, noise, and compressed air.

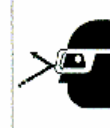
- Rotating cutting tools can severely injure you. **NEVER** place any part of your body near rotating cutting tools. Inspect cutting tools for damage before operating this machine. **DO NOT** operate this machine unless workplace is firmly secured to table.
- Rotating pulleys and belts can severely injure you. **NEVER** place any part of your body near rotating or moving parts. **ALWAYS** ensure guards are in place before operating this machine.
- High voltage electricity can severely injure or kill you. **NEVER** attempt to adjust or repair electrical circuits unless you are familiar with the circuits and are qualified to work safely on the electrical circuits. **ALWAYS** lock out electrical circuits before attempting to work on this machine.
- Exposure to loud or long term noise can lead to permanent hearing loss. **DO NOT** operate this machine without hearing protection. **ALWAYS** wear hearing protection that meets Occupational Safety and Health Administration (OSHA) standards for noise attenuation.
- Compressed air can injure you. **DO NOT** work on compressed air systems without first disconnecting the source of compressed air. **ALWAYS** wear eye protection when performing maintenance on compressed air systems. **ONLY** authorized qualified personnel familiar with the compressed air system should perform maintenance on the compressed air system.

LBL-0516A

Safety Instruction 2.

This label summarizes the hazardous situations that could result in serious injury or death when using the machine. Read the warnings carefully and follow the instructions to avoid serious injury or death. The safety instruction label 1. is used on all machines except for the TRM. The safety instruction label 2. is used only for the TRM.

3.1.2 ROTATING CUTTING TOOLS - DO NOT OPERATE WITH OPEN DOORS



Rotating Cutting Tools

Rotating cutting tools can cause serious injuries or death. Never get close to rotating tool. Do not operate the machine unless the doors are closed. Make sure that the door interlocks are working. In addition to the hazard of cuts and entanglement, the cutter can throw chips, break and throw part of the cutter, or grab and throw the part. Any of these can result in a serious injury or death.

3.1.3 MOVING PARTS - KEEP YOUR HANDS AWAY FROM MOVING PARTS

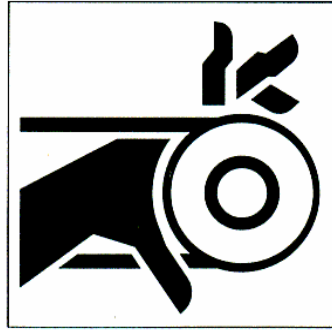

⚠ DANGER

Moving parts can cause serious injury. DO NOT operate with panels removed. Keep away from moving parts. Lockout power before service.

LBL-0129

Moving Parts

Pulleys, belts and gears can result in serious injury. The machine should not be operated with guards removed. Before service the machine should be powered off and power locked out.

3.1.4 HAZARDOUS VOLTAGES - LOCKOUT BEFORE SERVICING

⚠ DANGER

Hazardous voltages in this enclosure can kill. Servicing by qualified personnel only. Lockout before servicing.

LBL-0125

Hazardous Voltages

The electrical cabinet contains voltages that can be lethal. The machine should only be serviced by qualified personnel and power should be off and locked out before service.

3.1.5 ROTATING CUTTING TOOLS - DO NOT REMOVE OR MODIFY COMPONENTS

⚠ DANGER



Cutting tools can seriously injure or kill. Do not remove or modify components in this cabinet.

LBL-0235

Rotating Cutting Tools

The components and controls in the electrical cabinets are specially designed or selected for their function. Any change of the components can result in a loss of safety. Do not change or modify any components. Service should be performed by factory trained personnel only.

3.1.6 SPINDLE HEAD IS NOT COUNTERBALANCED

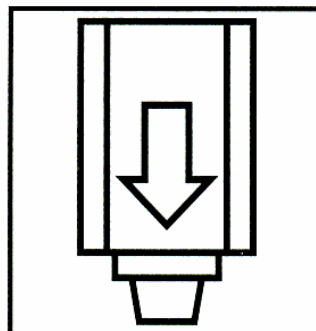

⚠ DANGER

Spindle head is not counterbalanced. Support or pin spindle head before working under spindle head or loosening Z-axis coupler or motor. LBL-0471

Not Counterbalanced Spindle Head

Many of the machine models use a brake built into the vertical axis servo motor instead of a counterweight to hold the vertical axis against the power of gravity when the machine is off. When working under the spindle head or when working on the servo motor or coupler, make sure that the head is locked in

place. Some machines use a large pin to accomplish this. Most use set screws that are built into the side of the spindle head.

3.1.7 VERTICAL AXIS - CRUSH HAZARD



Vertical Axis

When the vertical axis of the HMC moves, it includes the spindle motor which can be accessed from the back of the HMC. A guard restricts access to this area. When access to this area is required the HMC must not be moving. Never work under the spindle motor unless the machine is off and power is locked out.

3.1.8 AUGER AND CONVEYOR



Auger



Conveyor

Chips removal systems are very dangerous. Never try to unblock chips with your hand. Never stand in or near the auger or conveyor. Turn off and lock out power before doing any service on the auger or chip conveyor. If auger is jammed beware of stored energy in the auger. When freed it may move suddenly.

3.1.9 PALLET DOOR - HAND CRUSH



Pallet Door

When the pallet is in operation the operator and all others should keep away from the moving pallet and the automatic pallet door. Serious injury could result.

3.2 WARNING

“WARNING” - indicates a potentially hazardous situation which, if not avoided, could result in death or serious injury.

3.2.1 SHARP EDGES ON CUTTING TOOLS

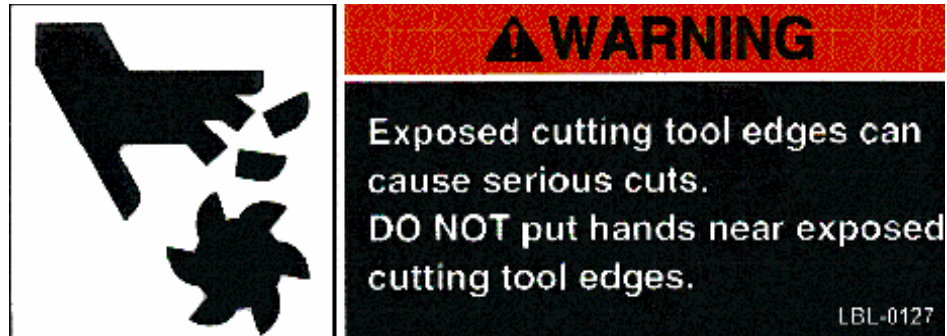

Cutting Tool Edges

Cutting tools can be very dangerous even when not moving. Keep hands and other parts away from all sharp edges. Do not handle sharp tools without gloves.

3.2.2 HAZARDOUS VOLTAGES - DO NOT OPERATE WITH DOOR OPEN

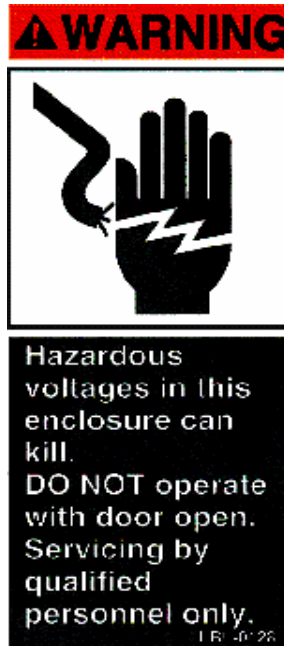

Hazardous Voltages

Potentially lethal voltage are present in the electrical cabinets. Keep the doors closed. Only factory trained personnel should service the machine.

3.2.3 READ OPERATOR'S MANUAL

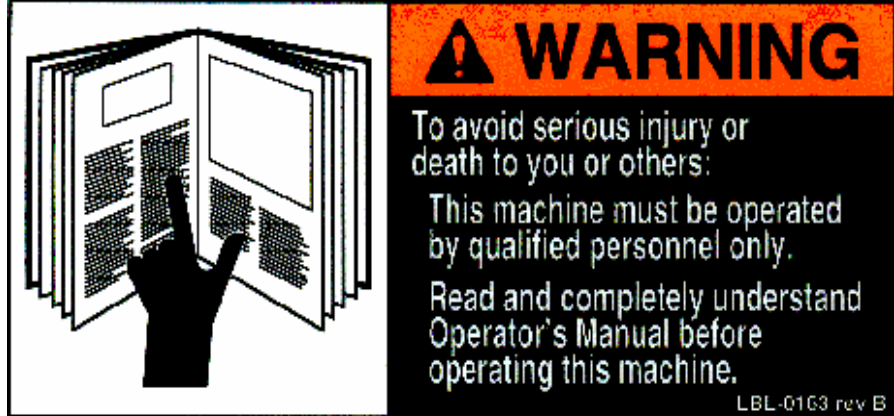

Reading Operator's Manual

The operator's manual contains information that is vital to the safe operation of the machine. Read and understand the manual before operating the machine. Only trained and qualified personnel should be allowed to operate the machine.

3.2.4 EYE AND EAR PROTECTION

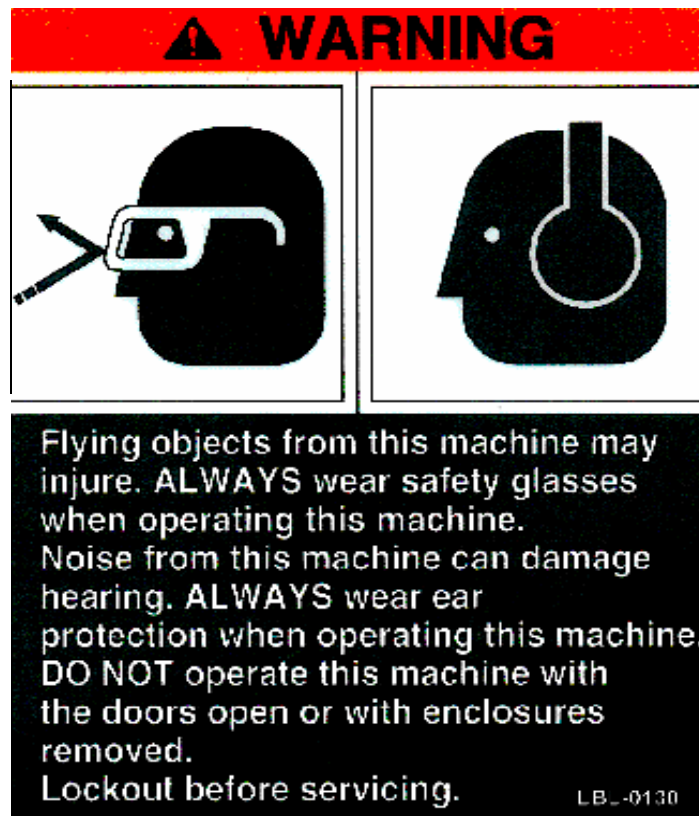

Eye and Ear Protection 1.



Eye and Ear Protection 2

Flying chips and loud noise are unavoidable consequences of machining. Always wear eye and ear protection. The eye and ear protection 1 label is used on all machines except for the TRM. The eye and ear protection label 2 is used only for the TRM.

3.2.5 VERTICAL AXIS MOVEMENT



Vertical Axis

The vertical axis of the HMC poses an impact hazard from the back of the machine. It also poses a more serious crush hazard. Do not operate the machine with the guard to this area open.

Turn off the machine and lockout power before doing any service or maintenance in this area.

3.2.6 COMPRESSED AIR



Compressed Air

Some of the systems on the machine use compressed air. Hoses can break or come loose. Wear eye protection. Never perform maintenance on systems that are pressurized. Disconnect the air source to the machine before performing any maintenance.

3.3 CAUTION

“CAUTION” -indicates a potentially hazardous situation which may result in minor or moderate injury.

3.3.1 WEIGHT - LIFTING
HEAVY DEVICES



Weight 1.



Weight 2.

Rotary heads are heavy. Depending on the weight, two men may be required. For heavier heads an overhead crane or other lifting device is needed. Do not over exert.

3.4 OTHER WARNINGS

3.4.1 HAZARDOUS VOLTAGES



Hazardous Voltages

This symbol indicates the presence of potentially lethal voltages. It is placed on enclosures that contain such voltages and sometimes near terminals. Any terminal in a cabinet so marked may have lethal voltages. Terminals that are not marked, but which are in such a cabinet, may still be lethal. Power off and lock out before opening any cabinets with this symbol. This label comes in 3 sizes.

3.4.2 SERVICE BY FACTORY AUTHORIZED PERSONNEL ONLY



Service Attention

Proper service and maintenance is required to maintain the performance and safety of the machine. Factory authorized personnel are trained to perform such service and have the spare parts to maintain performance and safety. Only factory authorized personnel should service the machine.

3.4.3 MAINTENANCE

LABELS: VMC & HMC,
EMC, & TRM

MAINTENANCE AND LUBRICATION

DAILY

1. CHECK AIR PRESSURE:
 - A: RIGHT REGULATOR 120 PSI MAX. (TOOL OUT ONLY)
 - B: LEFT REGULATOR 80-90 PSI
2. CHECK AIR FILTER:
 - A: DRAIN AND CLEAN WATER SEPARATOR.
3. CHECK WAY LUBE LEVEL (USE CASTROL MAGNA BD68, SHELL TONNA 68V OR MOBIL VACTRA #2 ONLY).
4. CHECK WAY LUBE SYSTEM FOR ADEQUATE FLOW TO ALL WAYS.
5. WITH THE TOOL IN SPINDLE BLOW CHIPS FROM AROUND A.T.C. AND SLIDE. NEVER BLOW CHIPS FROM THE AREAS DURING AUTOMATIC TOOL CHANGE OR WITHOUT A TOOL IN THE SPINDLE.
6. REMOVE HEAVY CHIP BUILD UP FROM GUARDS AND WAY COVERS.
7. WASH A.T.C. AND MACHINE WORK AREA.

WEEKLY

1. CHECK SPINDLE COOLER PUMP AND REFRIGERATION UNIT FOR PROPER OPERATION.
2. CLEAN A.T.C. SLIDE.
3. ACTIVATE (OPTIONAL) THRU-TOOL COOLANT SYSTEM FOR 2-3 MINUTES.
4. LUBRICATE Y AXIS TELESCOPING BALLSCREW COVER WITH WAY LUBE.
5. INSPECT ALL COOLING FANS. CLEAN IF NECESSARY.
6. CLEAN REFRIGERANT PUMP FILTER.

YEARLY

1. SERVICE WAY LUBE FILTER:
 - A: REPLACE BRONZE ELEMENT IN EXTERNAL FILTER.

LBL-0036

Maintenance Label 1.

FADAL EMC MAINTENANCE AND LUBRICATION

DAILY

1. CHECK AIR PRESSURE (80-90 PSI).
2. CHECK AIR FILTER, DRAIN AND CLEAN WATER SEPARATOR.
3. WITH TOOL IN SPINDLE, BLOW CHIPS FROM AROUND A.T.C. AND SLIDE. NEVER BLOW CHIPS FROM AROUND THESE AREAS DURING AUTOMATIC TOOL CHANGE OR WITHOUT A TOOL IN THE SPINDLE.
4. REMOVE HEAVY CHIP BUILD UP FROM GUARDS AND WAY COVERS.
5. CLEAN A.T.C. AND MACHINE WORK AREA.

WEEKLY

1. INSPECT COOLING FANS. CLEAN FAN SCREENS IF NECESSARY.

EVERY 6 MONTHS

1. LUBE THE RAILS AND BALL SCREWS.
 - A: REMOVE X, Y, AND Z WAY COVERS.
 - B: WIPE OFF OLD GREASE AND ACCUMULATED FOREIGN OBJECTS.
 - C: USE MOBILTEMP SHC 32 GREASE.
 - D: GREASE EVERY LUBRICATION PORT AT THE SADDLE, TABLE, AND HEAD. SUPPLY GREASE UNTIL IT COMES OUT FROM THE BALL SLIDE OR BALL NUT AREA.
 - E: MOVE SADDLE, TABLE, AND HEAD A FEW TIMES THROUGH FULL TRAVEL TO SPREAD THE GREASE THROUGHOUT THE SYSTEM.
 - F: WIPE OFF EXCESS GREASE THAT ACCUMULATES AT THE END OF THE RAILS AND BALL SCREW SHAFTS.
 - G: REPLACE X, Y, AND Z WAY COVERS.

LBL-0486A

Maintenance Label 2.

FADAL TRM MAINTENANCE AND LUBRICATION

DAILY

1. CHECK AIR PRESSURE (80-90PSI).
2. CHECK AIR FILTER. DRAIN AND CLEAN WATER SEPARATOR.
3. REMOVE CHIP BUILD UP FROM GUARDS AND WAY COVERS.
4. CLEAN MACHINE WORK AREA.

EVERY 6 MONTHS

1. LUBE THE RAILS AND BALL SCREWS.
 - A: WIPE OFF OLD GREASE AND ACCUMULATED FOREIGN OBJECTS
 - B: USE MOBIL TEMP SHC 32 GREASE.
 - C: GREASE EVERY LUBRICATION PORT AT THE SADDLE, TABLE AND HEAD. SUPPLY GREASE UNTIL IT COMES OUT FROM THE BALL SIDE SLIDE OR BALL NUT AREA.
 - D: MOVE SADDLE, TABLE, AND HEAD A FEW TIMES THROUGH FULL TRAVEL TO SPREAD THE GREASE THROUGHOUT THE SYSTEM.
 - E: WIPE OFF EXCESS GREASE THAT ACCUMULATES AT THE END OF THE RAILS AND BALL SCREW SHAFTS.

LBL-0518A

Maintenance Label 3.

Daily and weekly maintenance is essential to the continued performance and safety of the machine. Read and follow the maintenance label on your machine.

3.4.4 GROUNDING REQUIREMENTS

FADAL VMC GROUNDING REQUIREMENTS

FADAL VMC machines shall be grounded by any of the methods listed in article 250 of the National Electric Code. (see installation chapter of the FADAL VMC Maintenance Manual for details) The minimum grounding method recommended by FADAL is as follows:

- Grounding wire must be one continuous conductor, solid or stranded, no splices.
- Grounding wire must be copper wire with green insulation or a copper wire having green insulation with a yellow stripe.
- Grounding wire must be a No. 8 AWG or larger conductor.
- One end of this wire is connected to the protective earth bar in the back cabinet of the FADAL metalworking machine. The other end of the wire is connected to an applicable grounding lug in the power distribution panel of the building.

Grounding Requirements

Proper grounding is essential to the safety and performance of the machine. NEVER operate a machine that is not properly grounded.

4.0 CE SAFETY LABELS

The following labels have triangle, circle, and square or rectangle shapes:

4.1 TRIANGLES

“TRIANGLE” - warns of hazards.

4.1.1 ROTATING CUTTING TOOLS (CUTTING OFF FINGERS OR HAND)



Rotating Cutter

Cutting tools can seriously injure. NEVER place any part of your body near rotating tools. Do not operate this machine unless the doors are closed and the door interlocks are working.

4.1.2 BELT OR CHAIN DRIVE (HAND INTANGLEMENT)



Belt or Chain Drive

Rotating pulleys and belts can seriously injure. NEVER place parts of your body near rotating or moving parts. Always insure that guards are in place before operating this machine.

4.1.3 HAZARDOUS VOLTAGES (ELECTRIC SHOCK)



Hazardous Voltages

Hazardous voltages in the enclosures marked with this symbol can kill. Do not operate with the door open. Servicing should be done by qualified personnel only. Lockout the power before servicing. This symbol is also used near hazardous terminals. However, terminals not marked may still be lethal. Maintenance and service personnel must assume that any terminal, wire, or circuit board may contain lethal voltages when the cabinet is marked.

4.1.4 EYE AND EAR PROTECTION (FLYING DEBRIS AND LOUD NOISE)



Eye and Ear Protection

Flying objects from the machine can injure your eyes. Always wear safety glasses when operating the machine. Do not operate the machine with the open doors or with the removed enclosures. Also, noise from the machine can cause the problem with hearing. Always wear ear protection while operating the machine.

4.1.5 EYE PROTECTION (FLYING DEBRIS AND COMPRESSED AIR)



Eye Protection

Flying debris and compressed air can cause eye injury. Do not perform maintenance on pressurized systems. Disconnect the air source before performing maintenance. Always wear eye protection when performing maintenance on compressed air systems.

4.1.6 COMPRESSED AIR (SKIN PUNCTURE)



Compressed Air

Compressed air can seriously injure. Do not perform maintenance on pressurized systems. Disconnect air source before performing maintenance. Always wear eye protection and gloves when performing maintenance on compressed air systems.

4.1.7 AUGER AND CONVEYOR (LEG OR BODY ENTANGLEMENT)



Auger and Conveyor

The chip auger can seriously injure or kill. Keep body parts out of the auger system at all times. The chip conveyor is slightly less dangerous, but still can inflict serious injuries. Turn off the machine and lockout the power before doing maintenance inside the enclosure. Do not use hands to unblock chips.

4.1.8 MOVING PARTS (HAND CRUSH)



Moving Parts

The automatic pallet changer door can crush hands. Stay clear when the door is closing.

4.1.9 FORCE FROM SIDE (HAND CRUSH)



Force from the Side

The automatic pallet changer can crush hands or fingers. Do not hands or other parts of the body in the path of a moving pallet or near the pallet rails.

4.1.10 DRAWING IN (BODY INJURY)



Drawing In

The machinery behind the guard so marked can pull the operator in causing severe injury. Do not remove or reach under the guard. Do not do any service or maintenance unless the machine is off.

4.1.11 IMPACT FROM ABOVE

Impact from Above

Machinery moves vertically. Do not stand or work in area below moving machinery. Serious injury can result. This label indicates a hazard posed by the vertical axis of the HMC.

4.1.12 CRUSH FROM ABOVE

Crush from Above

Machinery moves vertically. Do not work in area below moving machinery. Crush hazard can cause serious injury or death. This label indicates a hazard posed by the vertical axis of the HMC.

4.2 CIRCLES

“CIRCLE” - indicates mandatory actions or prohibitions.

4.2.1 NO OPEN OR REMOVED GUARDS



No Open or Removed Guards

Do not operate the machine with the open doors or removed guards. Moving machinery and rotating cutters can seriously injure or kill.

4.2.2 WEAR EYE PROTECTION



Eye Protection

Flying objects can injure. Always wear safety glasses when operating the machine.

4.2.3 WEAR EAR PROTECTION

Ear Protection

Noise from the machine can cause the problems with hearing. Always wear ear protection when operating the machine.

4.2.4 READ OPERATOR'S MANUAL

Reading Operator's Manual

Read and understand the Operator's Manual before operating the machine. The machine must be operated only by qualified personnel.

4.2.5 LOCKOUT ELECTRICAL POWER



Lockout Electrical Power

Whenever servicing the machine, turn the machine off and lockout the power. Turn off the machine and lockout the power before working in this cabinet.

4.3 INFORMATION

4.3.1 MAXIMUM TOOL DIAMETER

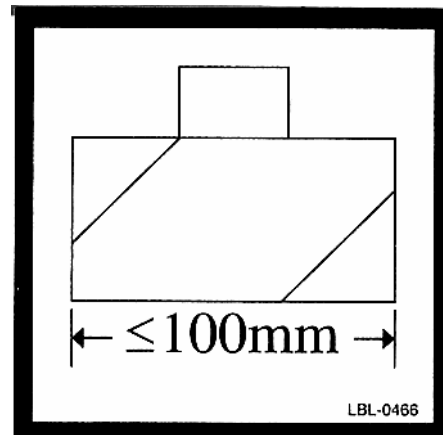
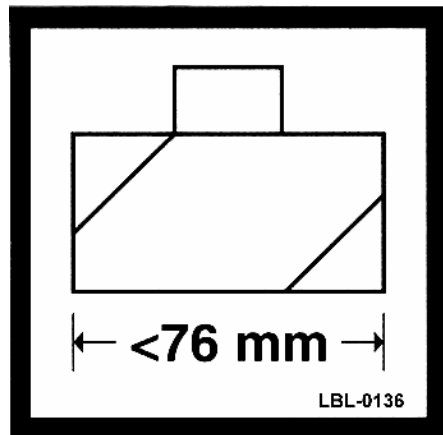

Maximum Tool Driver

The maximum allowable diameter of tools is dependent on the tool changer installed. Do not use tools larger than the marked maximum diameter.

4.3.2 MAXIMUM RPM

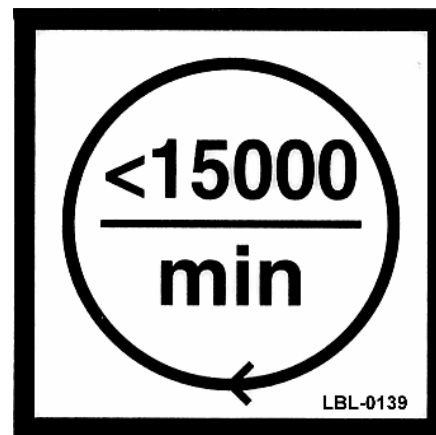
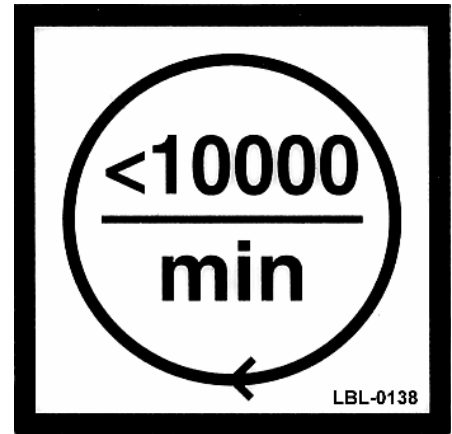

Maximum RPM

The maximum RPM of the spindle of the spindle is stated on by a label on the spindle head.

4.4 COMBINED SHAPES

Multiple shapes may be combined to express a more complex message.



Warns of moving pulleys or belt and requires power to be off and locked out before service.



Warns of sharp rotating cutters and prohibits opening the door while is in motion.



Warns of noise and flying objects, and requires eye and ear protection.

5.0 INDEX

**5.1 ALPHABETICAL
ORDER OF LABELS****A**

Auger and Conveyor 14, 26(CE)

B

Belt or Chain Driver 23(CE)

C

Caution 19

Circles 29(CE)

Combined shapes 33(CE)

Compressed Air (CE compliance) 6, 18, 25(CE)

Crush from above 28(CE)

D

Danger 8

Drawing in 27(CE)

E

Eye and ear protection 16, 24(CE)

Eye protection 25(CE)

Electric shock 5

F

Force from side 27(CE)

G

Grounding requirements 22

H

Hazardous voltages 11, 15, 20, 24(CE)

I

Impact from above 28(CE)

L

Lockout electrical power 31(CE)

M

Maintenance labels 21

Maximum tool diameter 31(CE)

Maximum RPR 32(CE)

Moving parts 11, 26(CE)

N

No open or removed guards 29(CE)

Noise (CE compliance) 5

P

Pallet door 14

Physical environmental and operating conditions CE specifications 6

Pictorials 4

Potential hazards to personnel 4

R

Read operator's manual 16, 30(CE)

Rotating cutting tools 4, 10, 12, 23(CE)

S

Safety instructions 8

Safety warnings 1

Service by factory authorized personnel only 20

Sharp edges on cutting tools 5

Spindle head not counterbalanced 12

T

Triangles 23

V

Vertical axis 13

Vertical axis movement 17

W

Warning 15

Warnings and cautions 4

Wear ear protection 30(CE)

Wear eye protection 29(CE)

Weight 19

5.2 NUMERICAL	LBL_0036	21
ORDER OF PART NO	LBL_0108	19
	LBL_0109	19
	LBL_0123	8
	LBL_0124	10
	LBL_0125	11
	LBL_0126	18
	LBL_0127	15
	LBL_0128	15
	LBL_0129	11
	LBL_0130	16
	LBL_0131	20
	LBL_0132	20, 24(CE)
	LBL_0136	31(CE)
	LBL_0137	32(CE)
	LBL_0138	32(CE)
	LBL_0139	32(CE)
	LBL_0158	14
	LBL_0163	16
	LBL_0187	22
	LBL_0234	14
	LBL_0235	12
	LBL_0263	20
	LBL_0430	25(CE)
	LBL_0431	23(CE)
	LBL_0432	23(CE)
	LBL_0433	26(CE)
	LBL_0434	23(CE)
	LBL_0435	24(CE)
	LBL_0436	26(CE)
	LBL_0437	31(CE)
	LBL_0438	31(CE)
	LBL_0439	29(CE)
	LBL_0440	30(CE)
	LBL_0441	29(CE)
	LBL_0442	30(CE)
	LBL_0443	27(CE)
	LBL_0460	25(CE)
	LBL_0461	20(CE)
	LBL_0466	31(CE)
	LBL_0468	27(CE)
	LBL_0471	12
	LBL_0486	21
	LBL_0509	17
	LBL_0510	13
	LBL_0516	9

LBL_0517 17
LBL_0518 22
LBL_0531 28(CE)
LBL_0532 28(CE)
LBL_0558 14(CE)