

SECTION 6

Pendant

WRG_0020D_pendant_wiring_1990_1_board

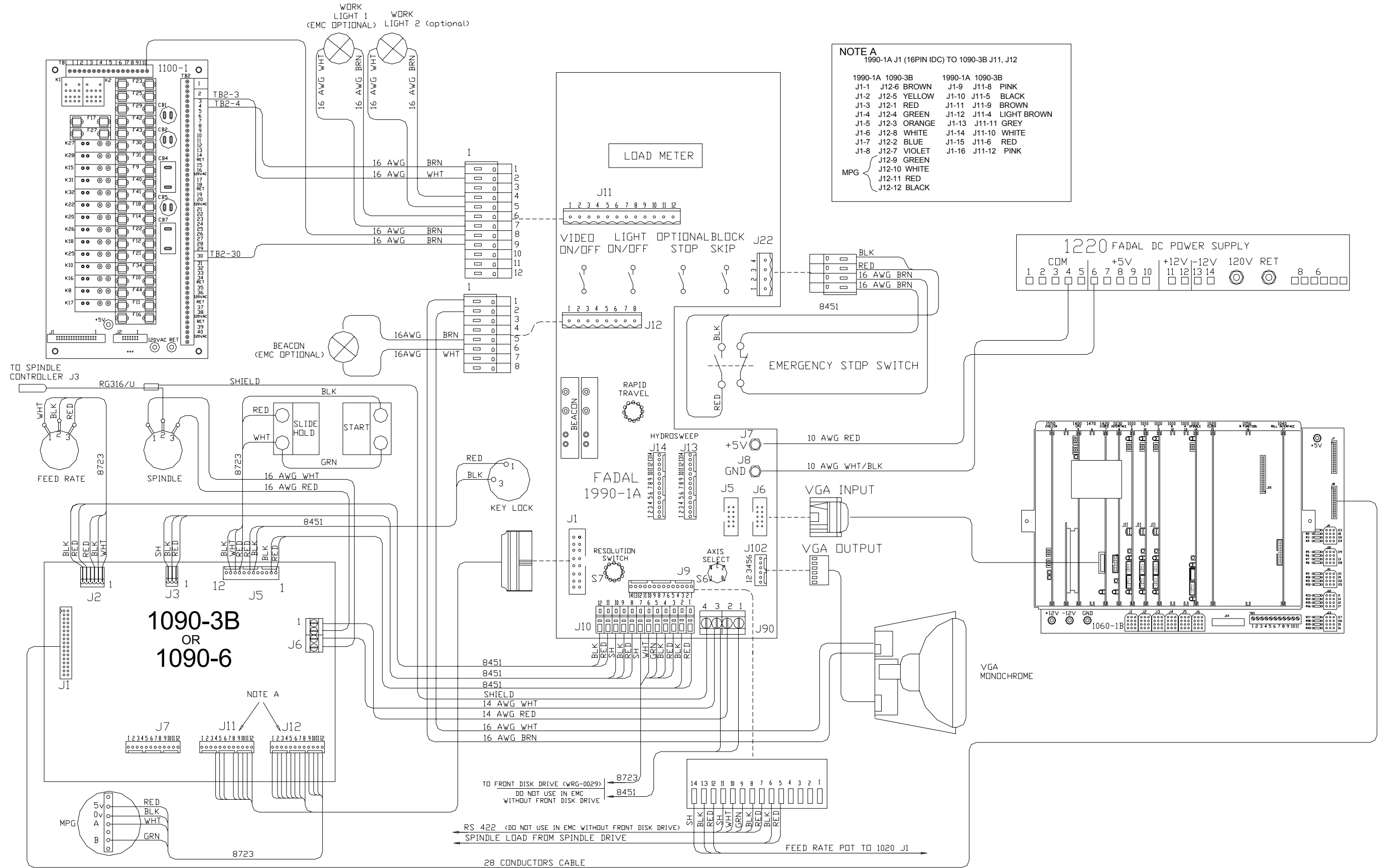

WRG_0021B_1990_2_board_32mp

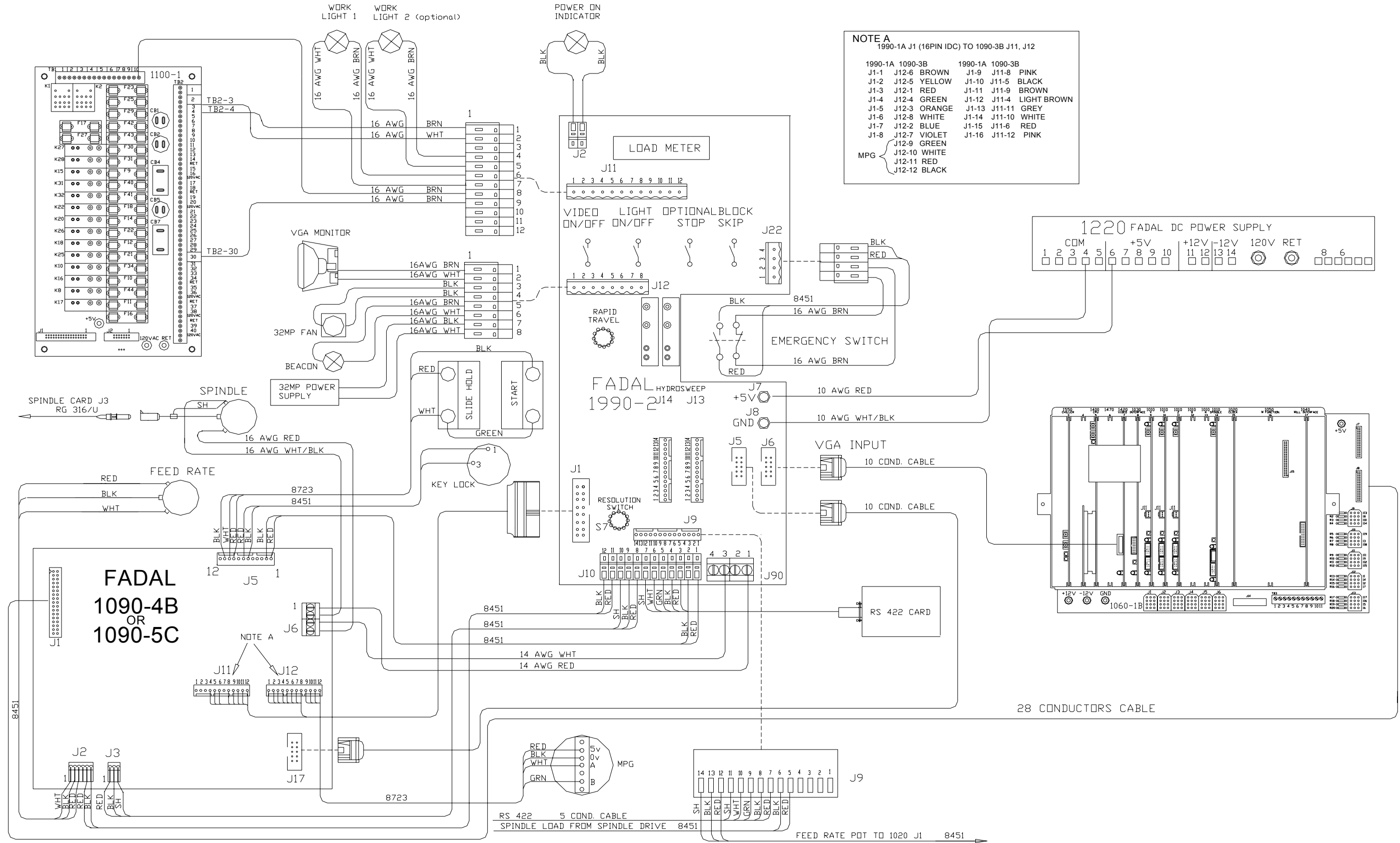

WRG_0025B_pendant_wiring_1990_1_board_color_vga

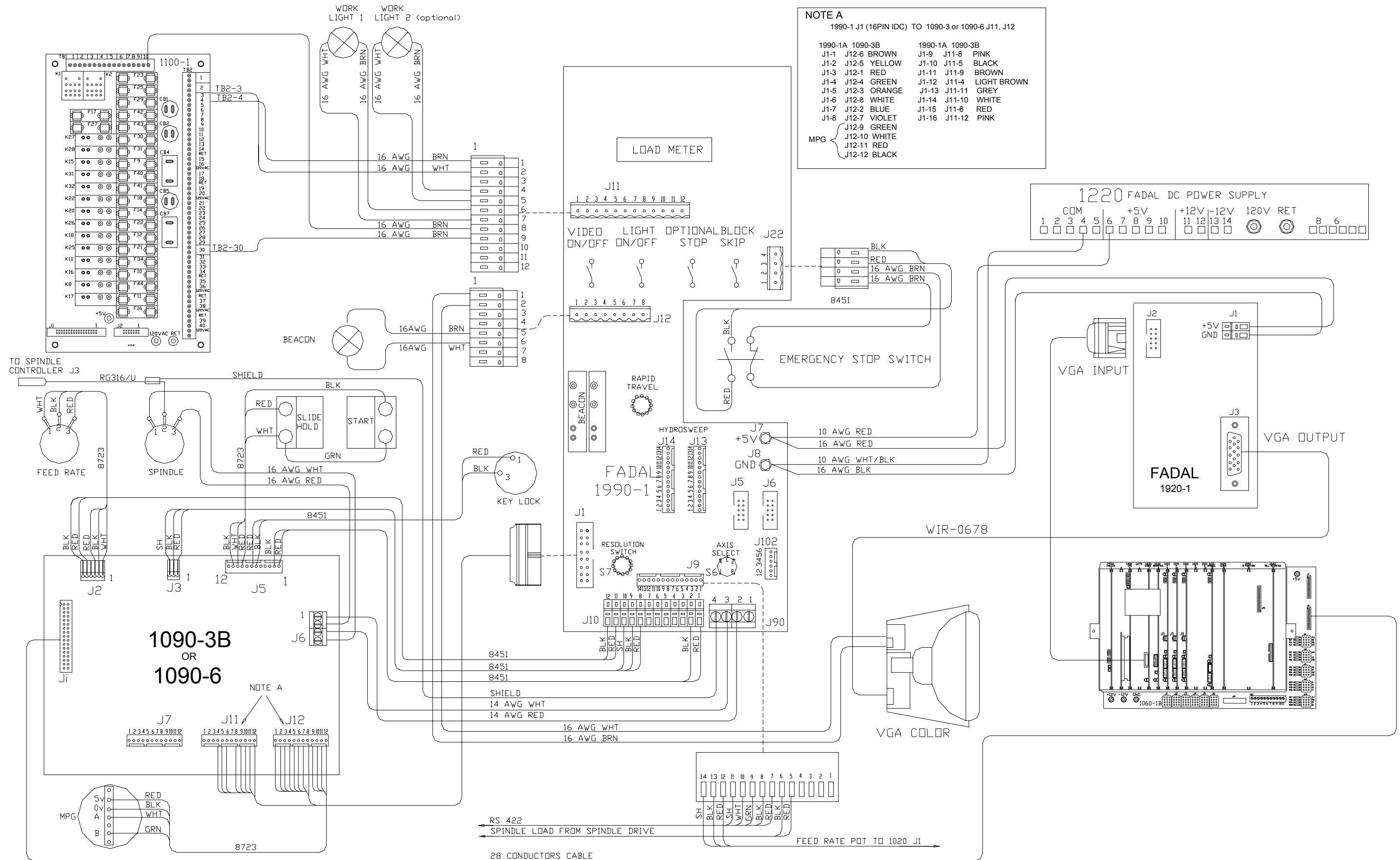

CNC 88/MULTI PROCESSOR

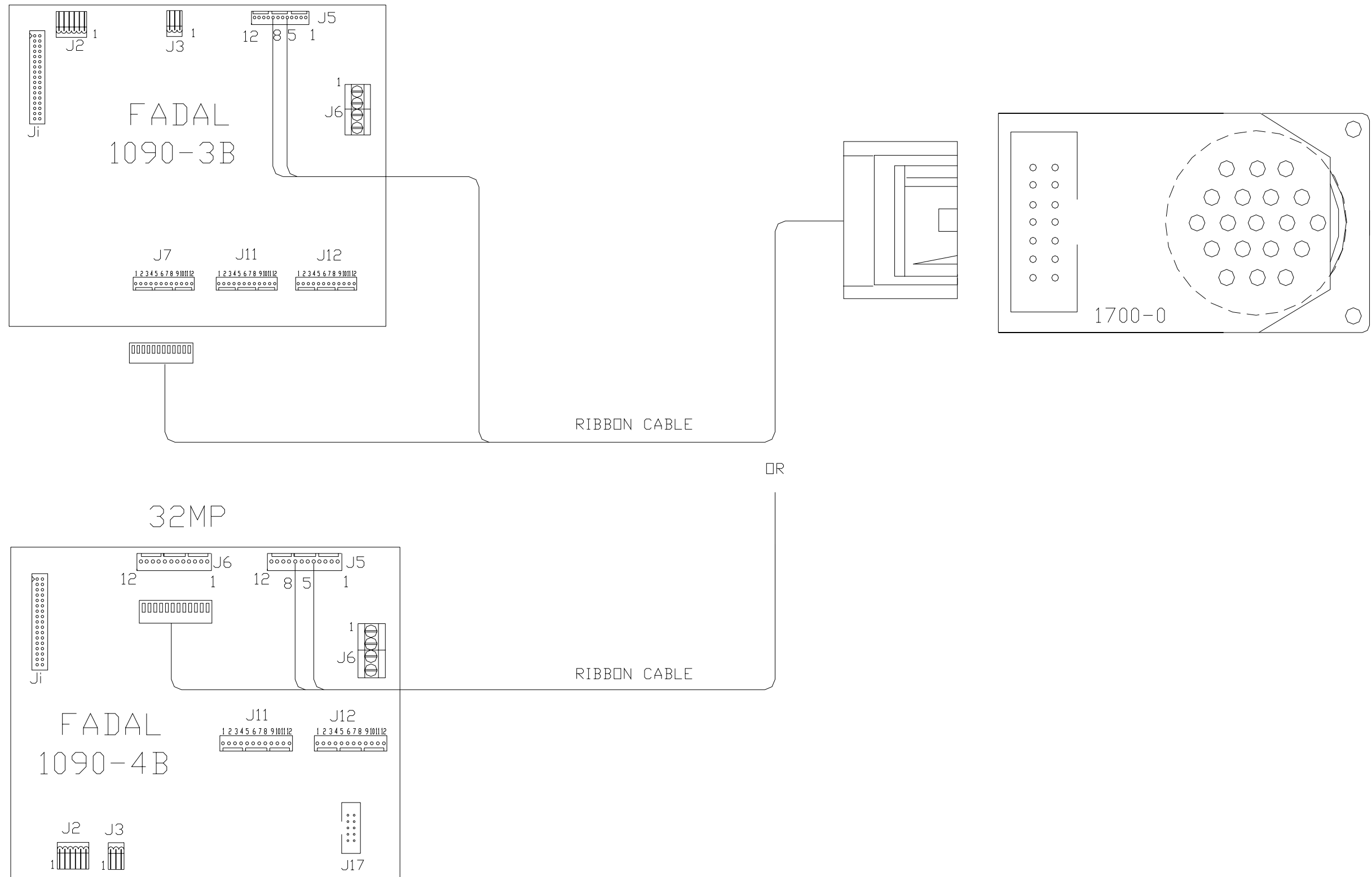

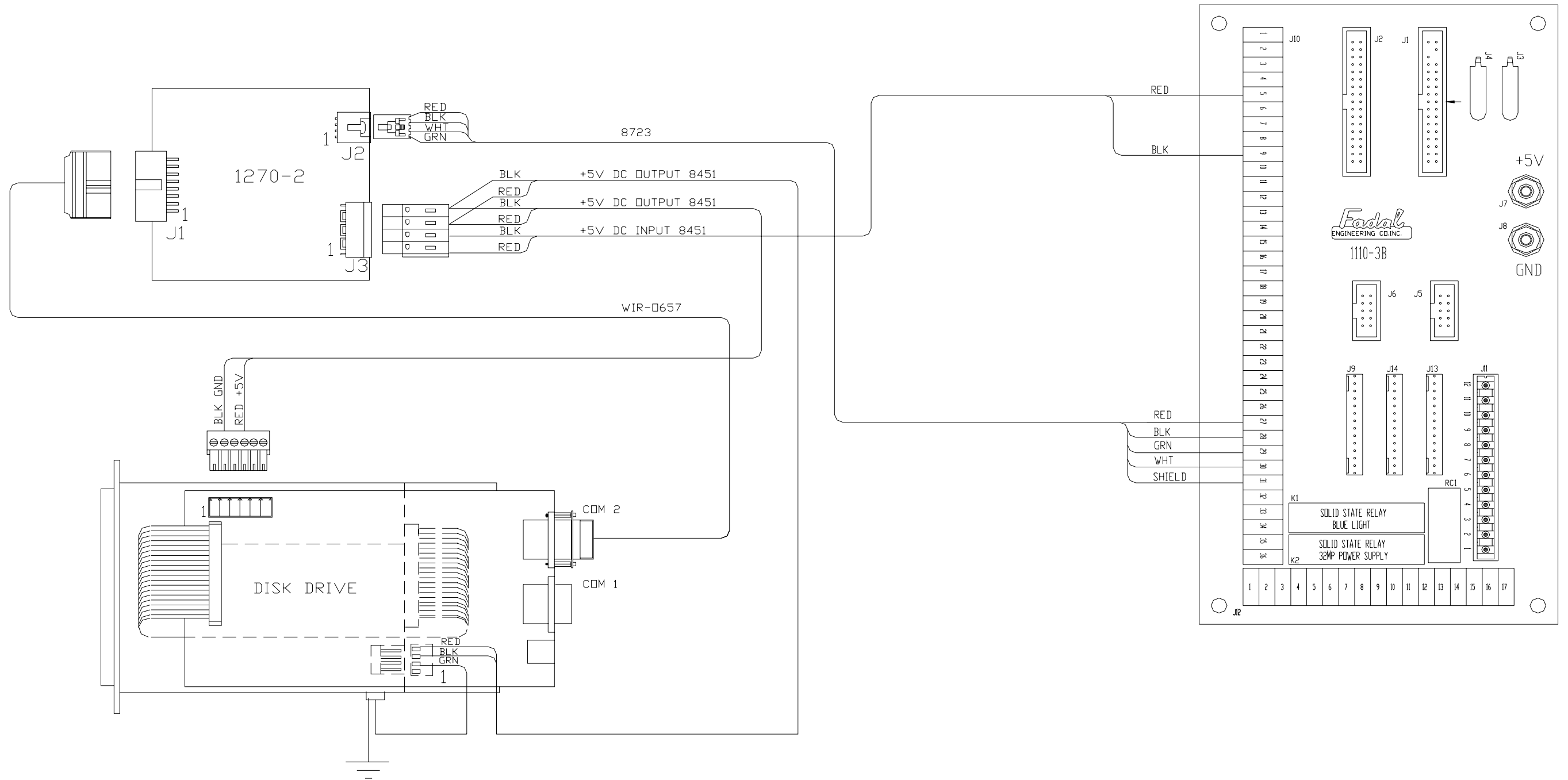

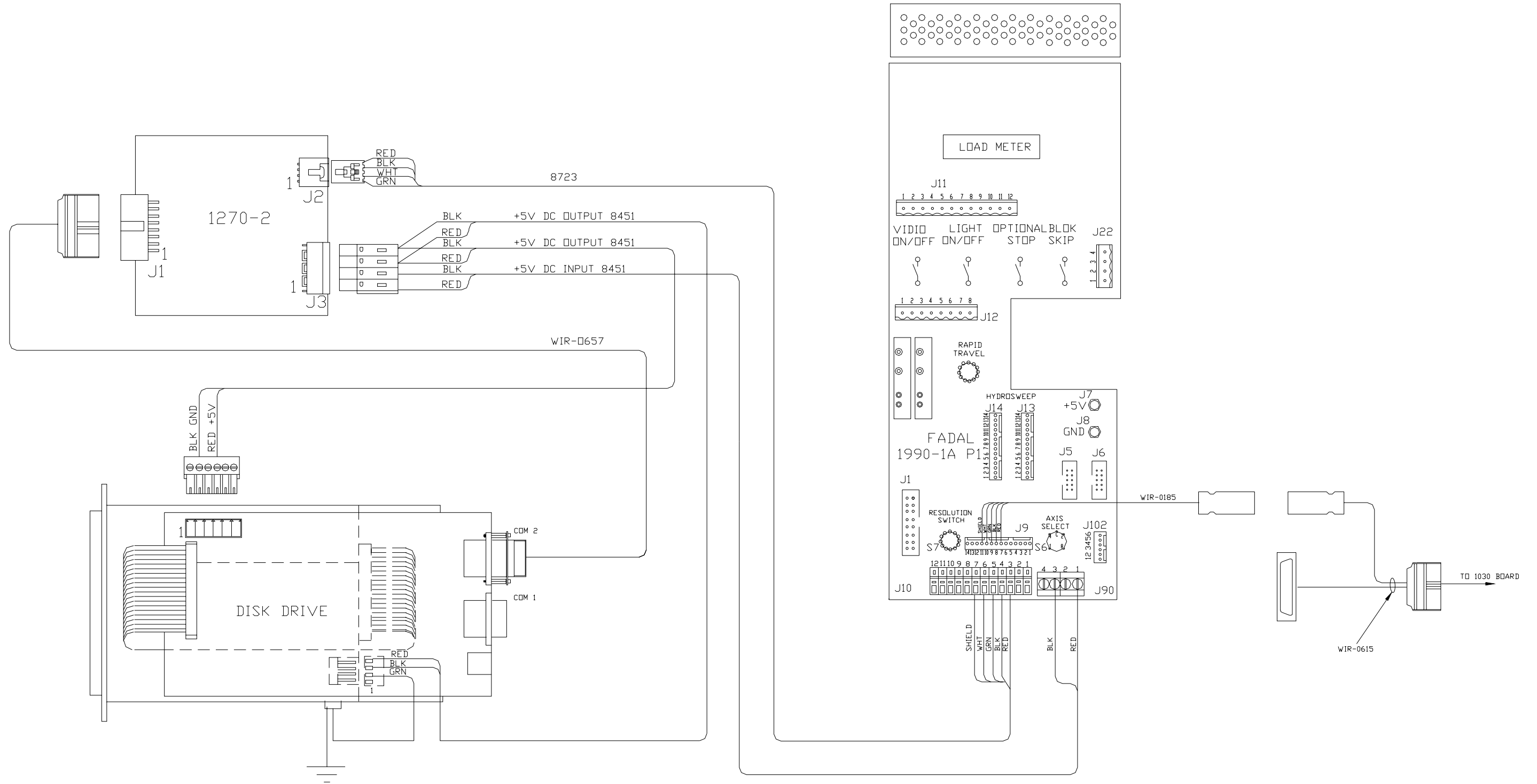

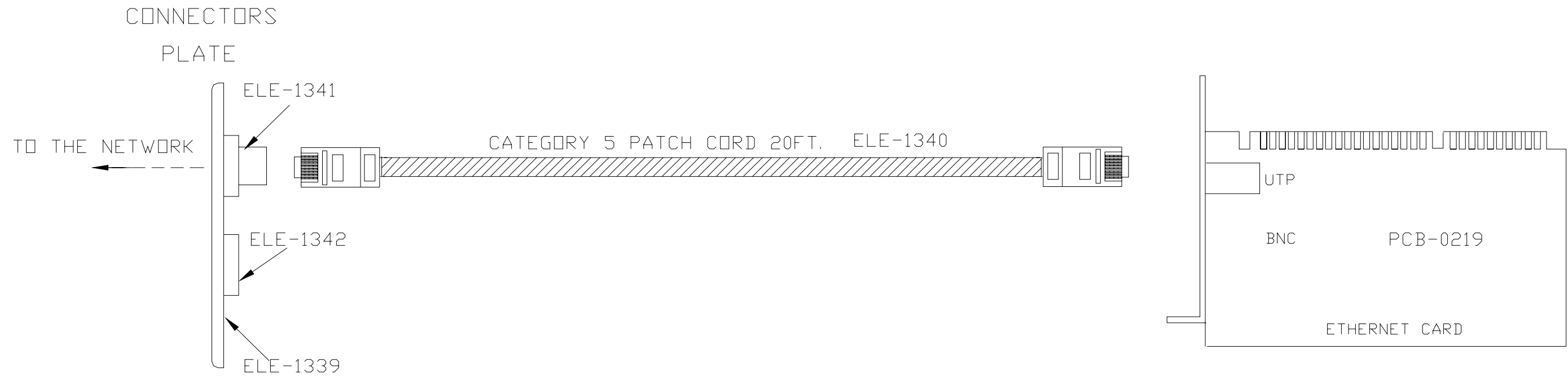

NOTE:

1. Install the Ethernet card into the PC chassis frame in 32MP control.
2. Install the connectors plate on the right bottom side of CNC cabinet for standard sheet metal and on the left bottom side of CNC cabinet for SLANT 98.
3. If the PC mother board is ETHERNET ready, connect the ETHERNET cables to the appropriate terminals on mother board.

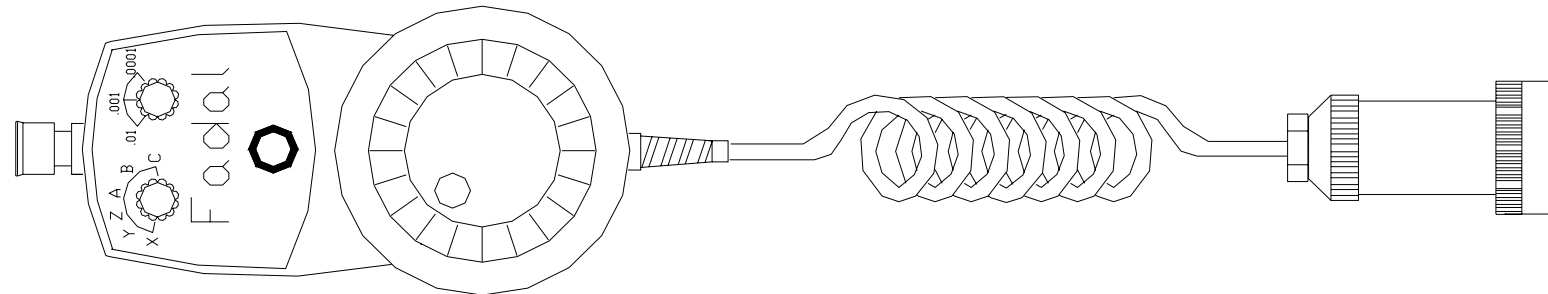
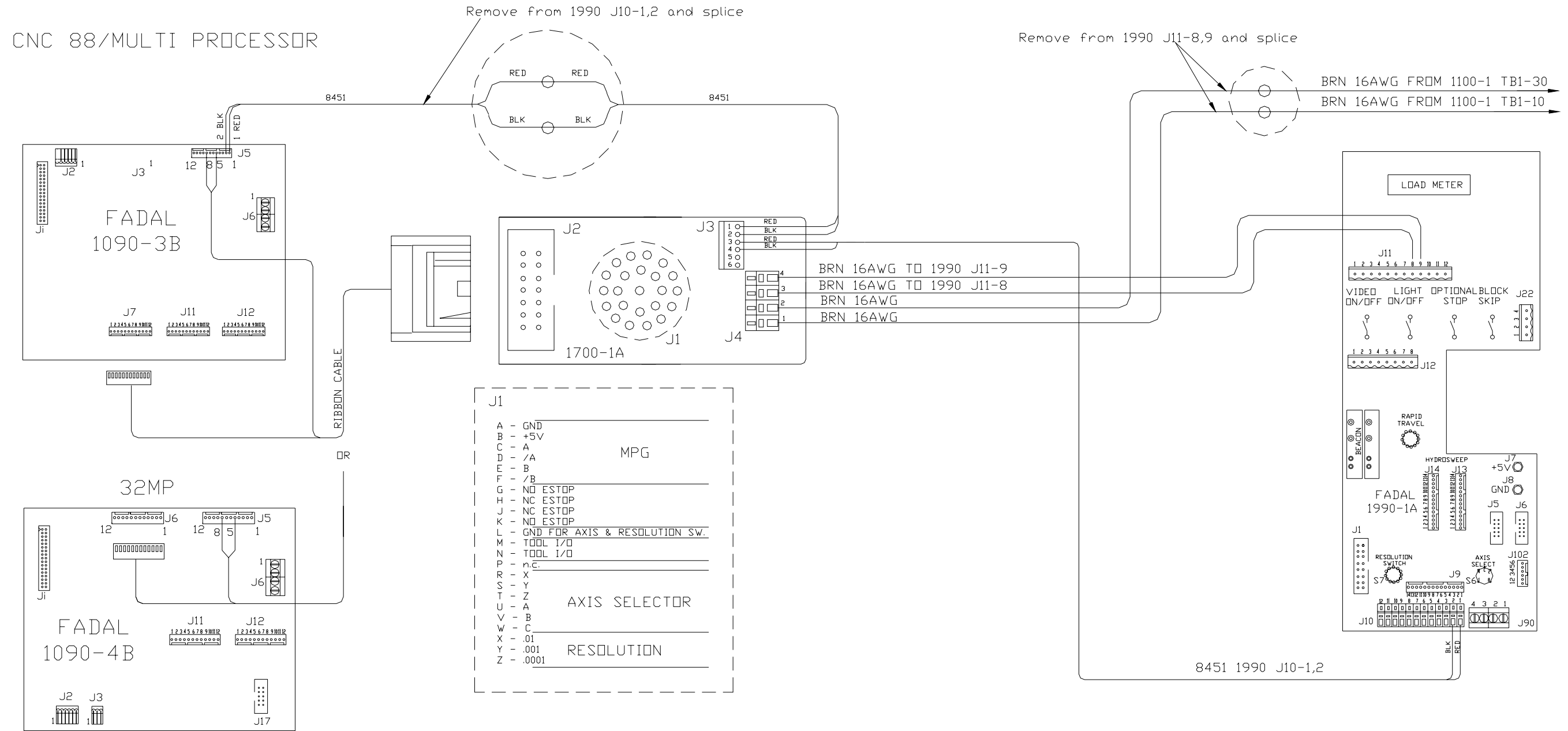

WRG_0057B_pendant_wiring_LCD_monitor

